

Smoke Alarm User's Guide

Model:

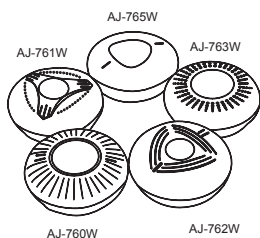

PACKING CONTENTS

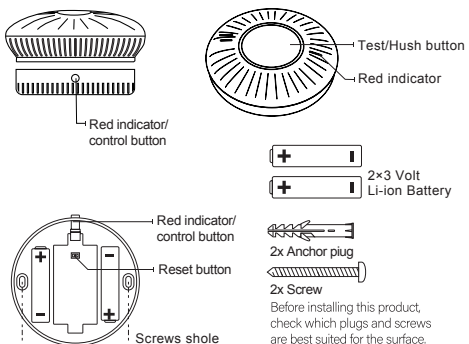

PARAMETERS :

Alarm Module
 Working Voltage DC 3V battery (non replaceble)
 Standby current <12uA
 Alarm current <35mA
 Low voltage threshold 2.7V

Wifi Module
 Working Voltage DC 6V battery (replaceble)
 Low voltage threshold 5.2V
 Lifespan >3 years
 Alarm mode LED & buzzer & APP alarm
 Size Ø 110 x H 57.15 mm
 Fire protection grade V-0

Frequency range: 2412-2472MHz
 Antenna gain: 2.5dB
 Max. Radio Transmission Power: 13dB

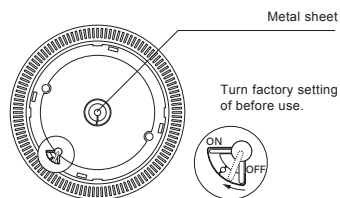

This product is intended for separate collection at a designated collection point. Do not dispose of the product with the household waste. For further information, please contact your local authorities.

Dispose of empty batteries in a designated battery recycling bin.



Contents

1. Set up
2. Installing the alarm
3. Where to install smoke detectors
4. Locations to avoid
5. Testing, maintenance & cleaning
6. Function description
7. What to do in case of a fire
8. Troubleshooting
9. Limitations of a smoke alarm
10. Limited Warranty

1.Set up

1 Download "TUYA Smart" Application by scanning the QR code or download from Google play store, connected with your phone with 2.4GHz Wi-Fi network.



2 Remove the insulation sheets found at both batteries. The RED indicator on the button flashes twice. If it is not removed, the detector will sound after buckling the WIFI base to alert NO BATTERY.

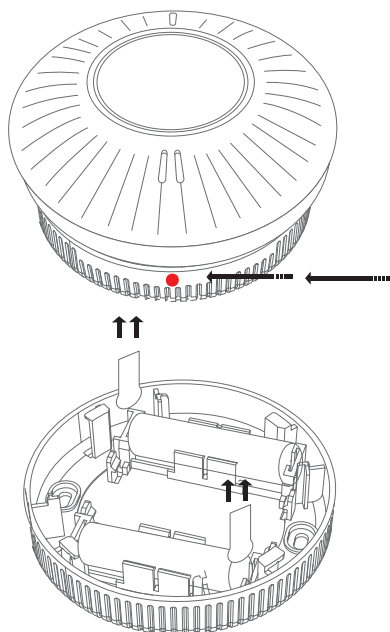

3 Open the APP. To add this device start by touching "Add device(+)" and chose "Sensor(WiFi)" from "Security sensor" list.

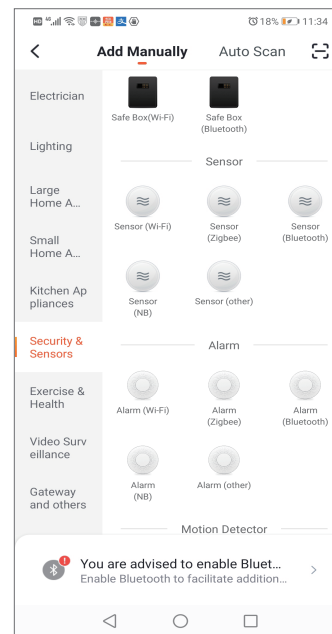

4 Write down your network name and password.
 Note: This item only works on a 2.4GHz Wi-Fi network, not on a 5GHz Wi-Fi network. You should change the Wi-Fi -frequency of your network to 2.4GHz network in the setting menu of your router.

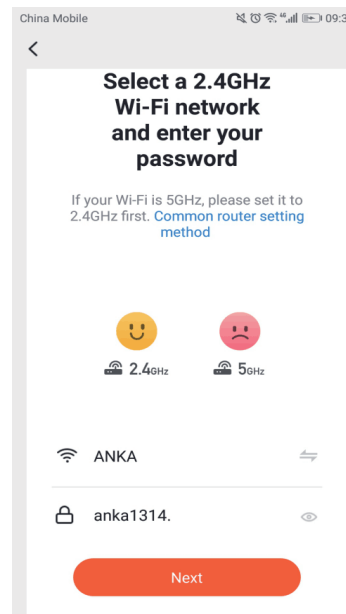

5 Press and hold the control button. Release it until indicator is blinking fast.

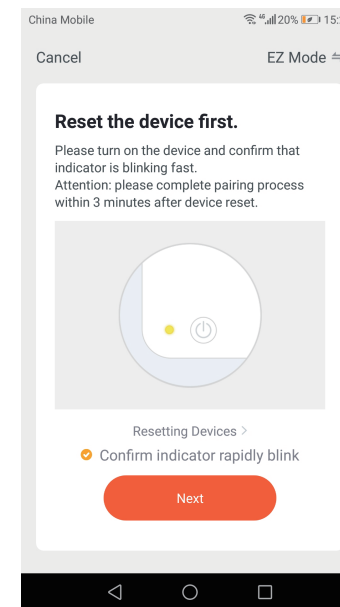
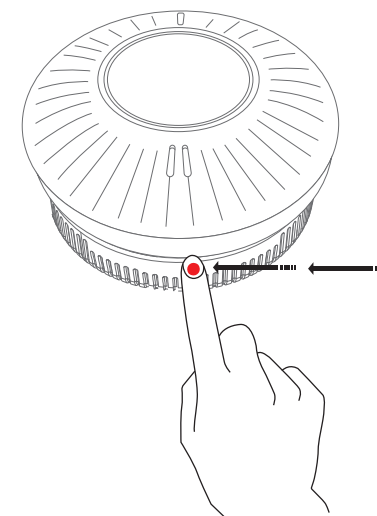

6 Adding device. It takes about 1 minutes.

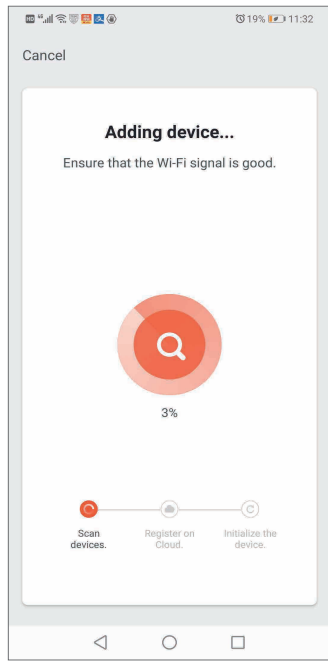

7 Added successfully, Click done. A "DIDI" sound sounds after successful installation.

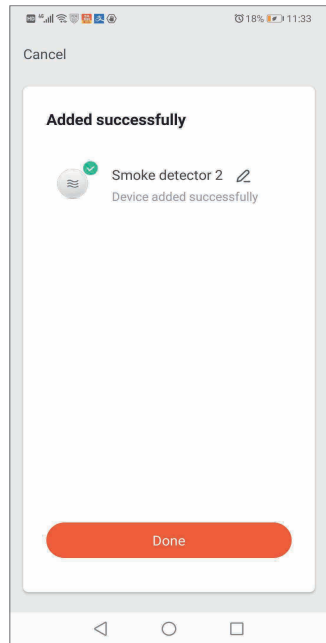

8 If failed , please repeat from step 3.

9 Press the test button for a duration of two seconds. The alarm will sound a few short, loud beeps. Upon releasing the button, the sound will stop. The APP will receive a test signal after ten seconds. The alarm is loud in order to alert you in case of an emergency and can be harmful to your ears.

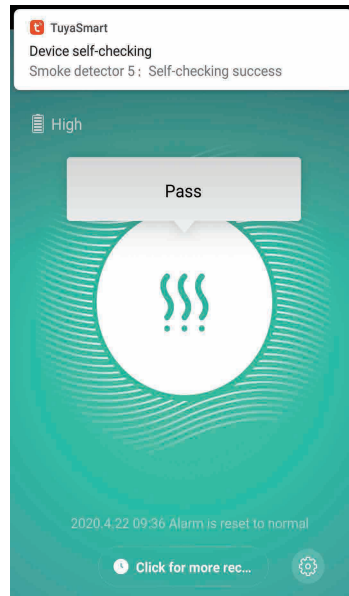
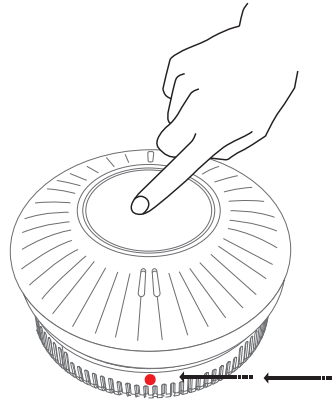

10 After the detector triggered, if you want to hush the detector, follow the on-screen prompts to click "Alarming.Click to turn off the sound".

Note: Smoke alarm Wi-Fi module will be activated 10 minute after be triggered, during this period remote muted is available.

After hush the smoke Alarm , it will stay silence for about 9 minutes. If there are still smoke detected after 9 minutes, it will sound again.

Ways to Hush:

1. Click the mute button on the APP.
2. Press the TEST/HUSH Button for a duration of two seconds.

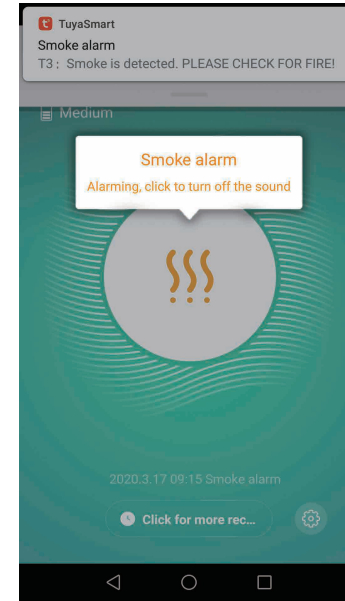

Optional method to Connect with APP:

In case the Wi-Fi signal is not so stable .We can use the second way to connect with the detector
Press and hold the control button until it blinks slowly. Manually select the device hotpots (Device name: Smartlife_XXX) click "Go Connected" and waiting for connection

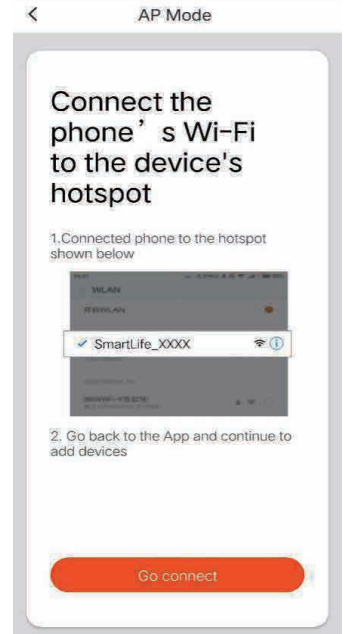

2. Installing the alarm

Be careful not to press the button on top of the alarm module unless you intend to do so. Pressing this button will cause the alarm to sound, the sound is very loud and may cause harm to your hearing.

1.1 Preparation

Determine how many alarms you need and where best to install them. See § 3 for more information on locations and § 4 for locations to avoid.

Before installing this product, check which plugs and screws are best suited for the surface.

2.2 Installation

Disconnect the alarm module from the base module by twisting the base module counter clockwise.

The smoke detector will power on automatically after the alarm module is buckled on to the Wi-Fi module.

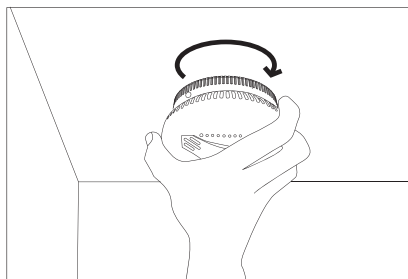
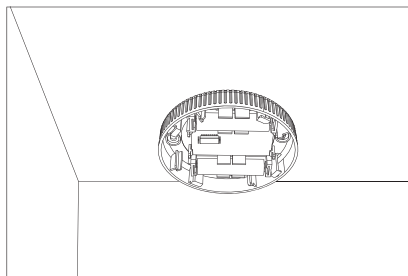

You can also turn on the alarm module manually by turn off the factory setting in the Alarm Module.

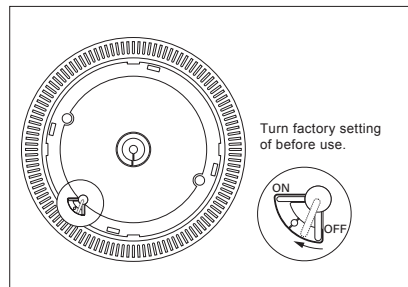

Alarm module > Disable the factory lock by pushing the lever clockwise.

Wifi module > Remove both plastic battery protection slips.

After installing the alarm, attach the alarm module back on the WiFi module. Turn till you feel a click to ensure the Alarm Module is buckled in to place.

3. Where to install smoke detectors

We recommend at least one smoke alarm per floor, per room.

3.1

As a minimum, smoke alarms should be located between sleeping areas and potential sources of fire such as living rooms and kitchens. In single storey homes with one sleeping area, a smoke alarm should be installed in the hallway, as close as possible to the living accommodation. To ensure audibility in bedrooms, no smoke alarm should be further than 3m away from any bedroom door. It may be necessary to install more than one smoke alarm, particularly if the hallway is more than 15m long. In single storey homes with two separate sleeping areas, a minimum of two smoke alarms is required, one outside each sleeping area. In multilevel or split level homes, as a minimum one smoke alarm should be installed on the ground floor between the stair case and any rooms in which a fire might start and on each storey in circulation areas which form part of escape route (normally hallways and landings).

3.2

Additional alarms should be installed in bedrooms in anticipation of fires originating here, caused by faulty wiring, lights, appliances, smokers or other hazards.

3.3

For best protection, smoke alarms should be installed in every room in your home, apart from those listed in the Section 4.

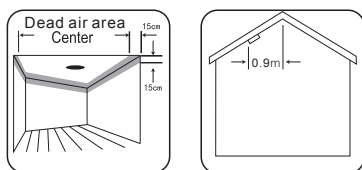

Single Story
one sleeping area

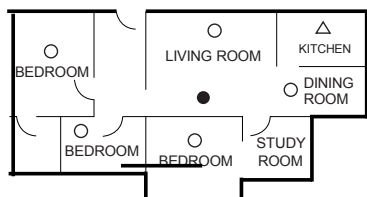

Single Story
more than one sleeping areas

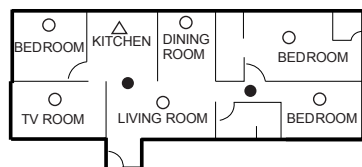

PAGE:07

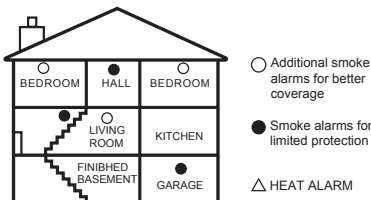

4. Locations to avoid

DO NOT locate smoke alarms:

- In turbulent streams of air such as near fans, heaters, doors and windows, etc. These can draw smoke away from the alarm.
- In high humidity areas such as bathrooms and shower rooms as high humidity can trigger the alarm, or where temperature exceeds 40 °C or below 0 °C.
- At the apex of an "A" frame ceiling. "Dead air" at the top may prevent smoke from reaching the alarm in time to provide early warning.
- Less than 300mm (12 inches) from the wall when mounted on the ceiling.
- In insect-infested areas. Tiny insects may affect performance.
- In kitchens, boiler rooms, laundry rooms, garages. Combustion particles from cooking or car exhausts and dust and moisture could trigger the alarm.
- In very dusty or dirty areas. Dirt and dust can build up and impair performance.
- Within 300mm (12 inches) of light fittings or room corners.
- In locations which would make routine testing or maintenance hazardous (e.g. over a stairwell).
- On poorly insulated walls or ceilings.
- Near objects such as ceiling decorations which might impede the path of smoke to the alarm.
- Within 1500mm (5 feet) of fluorescent light fittings.

5. Testing, maintenance and cleaning

This unit has been designed to be as maintenance-free as possible, but there are a few simple things you must do to keep it functioning properly:

5.1 Test each alarm at least once a week

Keep at arms length distance to the alarm during the test. The alarm is loud in order to alert you in case of an emergency and can be harmful to your ears. Press the button (3) for a duration of two seconds. The alarm will sound a few short, loud beeps. Upon releasing the button, the sound will stop. The APP will receive a test signal after ten seconds.

5.2 Reset the alarm

If the test does not function properly, reset the wifi base.

Repeat the steps above.

Replace or return the alarm if the test does not function properly after completing these steps.

5.3 Cleaning

Clean the smoke alarm at least once a month; gently vacuum the outside of the smoke alarm using your household vacuum's soft brush accessory. Test the smoke alarm after cleaning. Never use water, cleaners or solvents since they may damage the unit.

If the smoke alarm becomes contaminated by excessive dirt, dust and/or grime, and gives unwanted alarms, replace the unit immediately.

6. Function Description

Low voltage alarm: When the built in battery voltage of the smoke detector is below 2.7V, the red indicator light flashes once every 50 seconds, accompanied by a 'D' sound. The app will (also) show a warning in the status bar.

Smoke alarm fault: The LED of the smoke alarm flashes once every 8 seconds and is accompanied by a buzzer. The App status displays an alarm fault.

If the device operates normal, the red LED indicator flashes once every 55 seconds.

Wifi Module batteries: The battery life of the base batteries is 3 years. If the power indicator in the App turns low battery you need to replace the batteries in the Wifi Module to ensure communication is maintained.

Batteries required: Make sure 2 pieces DC3Volt Lithium batteries on the base. If NO battery or install batteries less than DC3Volt, the detector will sound after buckling the WiFi base or indicate LOW Battery.

7. What to do in case of a fire

Contact your local fire department for what you can do in case of a fire.

8. Trouble shooting

Reset procedure: If the device fails to access the network or crashes due to incorrect operation, please unscrew the wifi module and press the reset button to restart the installation procedure.

Problem: Red LED flashes and the alarm sounds one beep every 50 seconds.

Solution: The alarm module battery has ran out, replace the unit.

Problem: No response during APP operation.

Solution: Check that the network and the power supply are normal.

Problem: the APP battery indicates red.

Solution: The Wifi Module battery is exhausted. Please replace the batteries.

Problem: Smoke alarm is being triggered when the residents are cooking or showering.

Solution: 1, clean the detector, refer to section 5 "Testing, maintenance and cleaning"; 2, install the detector to another place, refer to section 3 "Installation Location".

Problem: The detector sound at soon as buckling with the Wi-Fi base.

Solution: Check DC3Volt batteries are correctly installed on the base and the insulation sheets are removed.

Problem: The alarm module sound as soon as hold the smoke alarm.

Solution: Do not touch the metal sheet found at the backside of the alarm mould.

9. Limitations of some alarms

Smoke alarms have played a key role in reducing deaths resulting from home fires worldwide. However, like any warning device, smoke alarms can only work if they are properly located, installed, and maintained, and if smoke can reach the alarms.

- Smoke alarms may not wake all individuals.

- Smoke alarms cannot detect fires if the smoke does not reach the alarms. Smoke from fires in chimneys or walls, on roofs or on the other side of closed doors may not reach bedroom or sleeping area - especially if the bedrooms or sleeping area doors are closed at night.

- Smoke alarms may not have time to sound before the fire itself causes damage, injury, or death, since smoke from some fires may not reach the unit immediately. Examples of this include persons smoking in bed, children playing with matches, or fires caused by violent explosions resulting from escaping gas.

- Smoke alarms are not foolproof. Like any electronic device, smoke alarms are made of components that can wear out or fail at any time. You must test the unit weekly to ensure your continued protection. Smoke alarms cannot prevent or extinguish fires. They are not a substitute for property or life insurance.

- Smoke alarms have a limited life. The unit should be replaced immediately if it is not operating properly. You should always replace a smoke alarm after 10 years from date of purchase. Write the purchase date on the space provided on back of unit.

10. Limited warranty

Copyright Notice: The copyright of this manual is owned by the manufacturer. All copyright is reserved. Except as permitted by copyright law, no one may copy, adapt or translate without prior permission.

Warranty: The contents of this manual are subject to change without prior notice. For the latest information, please contact the manufacturer. The manufacturer is not liable for any damage caused by errors in this manual and is not liable for damages caused by the provision or use of this manual.

The manufacturer can never be made liable for loss and / or damage of whatever nature, including incidental and / or consequential loss, arising from the fact that the signal from the smoke alarm did not sound during smoke or fire.